

P23-2

Product code: 8623202
EAN code: 5904996205188

PROFILE TYPE	LED TAPE WIDTH
architectural	up to 5x8 mm up to 4x10 mm up to 3x12 mm
COLOUR VERSIONS	LENGTH
silver anodised painted in white painted in black anthracite grey others - on demand	1000 mm 2000 mm 3000 mm 4000-6000 mm (on demand)

TECHNICAL DRAWING WITH DIMENSIONS

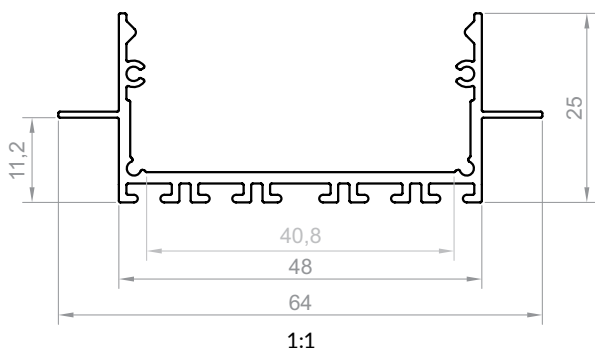

INSTALLATION INSTRUCTIONS



COVERS (CLICK-FIT)

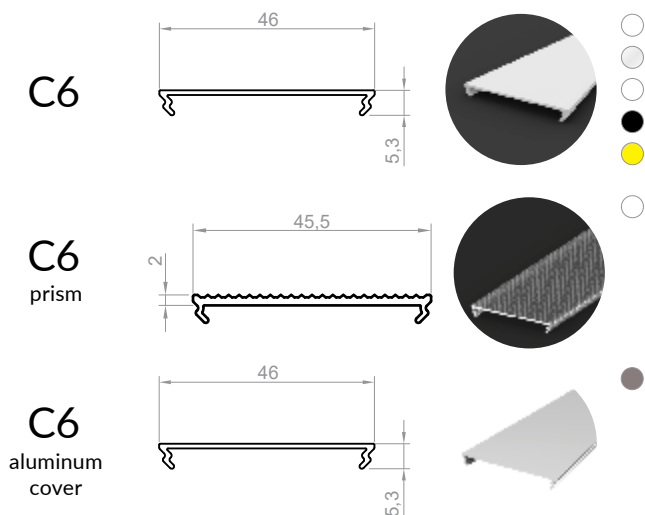

END CAPS

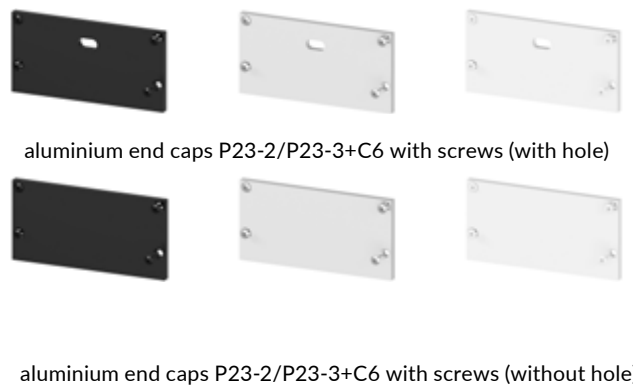

ACCESSORIES AND INSTALLATION



ACCESSORIES AND INSTALLATION

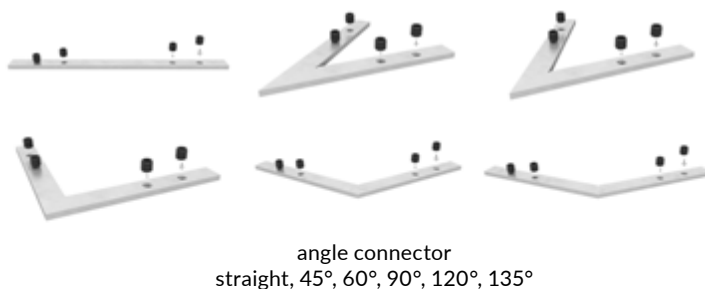

P23-2

